

AJ Oxford Table Lamp

AJ Oxford Table Lamp - 5744168601

This table lamp emits a pleasant downward directed light, which harmoniously illuminates the surface below it through the soft transparency of the three-layered mouth-blown opal glass. The variant without the top metal shade, the milky opal glass shade provides further glow to form an alluring halo around the fixture.

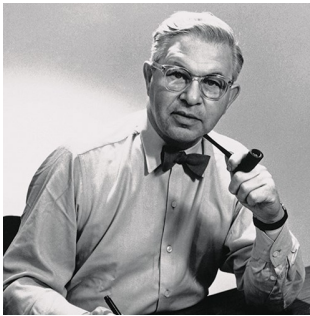

Arne Jacobsen

Arne Jacobsen was born and raised in Copenhagen. In 1927, he graduated as an architect from the Royal Danish Academy of Fine Arts in Copenhagen. After graduating, he obtained his first job at the office of the City Architect of Copenhagen launching his own office only two years later.

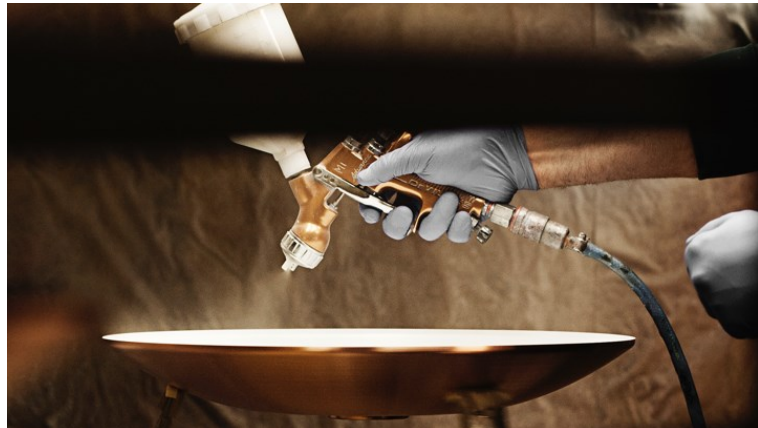

Product info

Information

Union nut and fingerscrew in untreated brass which will patinate. Pin solution for 410 mm with metal shade and 280 mm variants available upon request.

Mounting

Cable type: Black textile cord 2x0.75 mm² with plug. Cable length: 2.2m. Light control: On/off switch on socket house with union nut in untreated brass. Pin solution available for 410 mm: Cut-out dimension Ø44 mm, table thickness: 8 - 40 mm.

Finish

Black wet painted stem with shade in three layered mouth-blown opal glass. Top shade: Black wet painted with white inner side.

Materials

Shade: Mouth-blown three layered white opal glass. Stem and top shade: Steel. Mounting device for pin mounting: Aluminium. Union nut and finger screw in untreated brass with fine clockwise hairlines. Please note the untreated brass will patinate.

Sizes and weights

Width x Height x Length (mm) | 220 x 413 x 220 Max 1.2 kg | 220 x 284 x 220 Max 1.1 kg | 220 x 410 x 220 Max 0.9 kg

Class

Ingress protection IP20. Electric shock protection II.

Light source

1x20W E14

Information

Union nut and fingerscrew in untreated brass which will patinate.

Pin solution for 410 mm with metal shade and 280 mm variants available upon request.

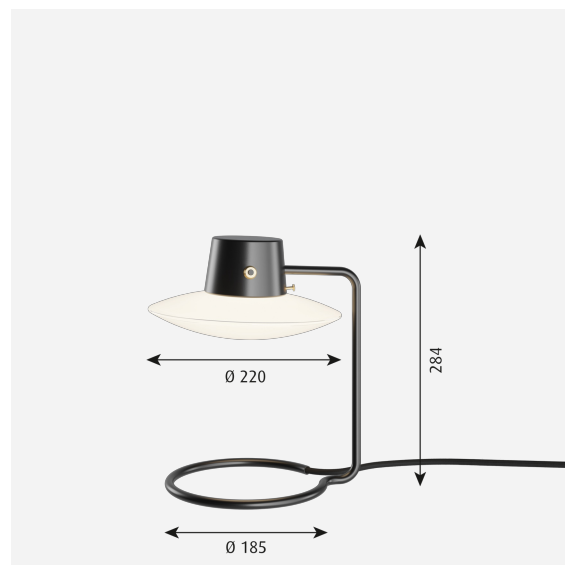

Product family



AJ Mini Table



AJ Royal



AJ Garden Bollard



AJ Table

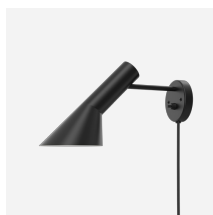

AJ Wall



AJ Floor



AJ 50 Wall

Light distribution diagrams

Cartesian

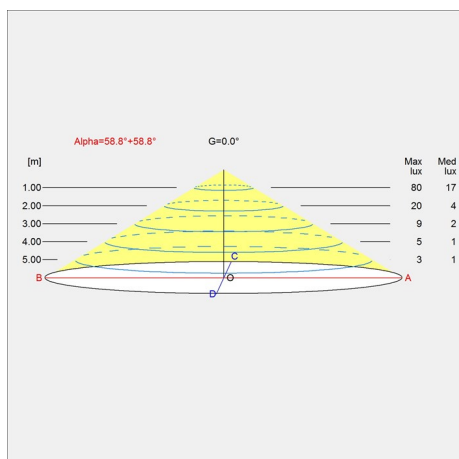

Isolux

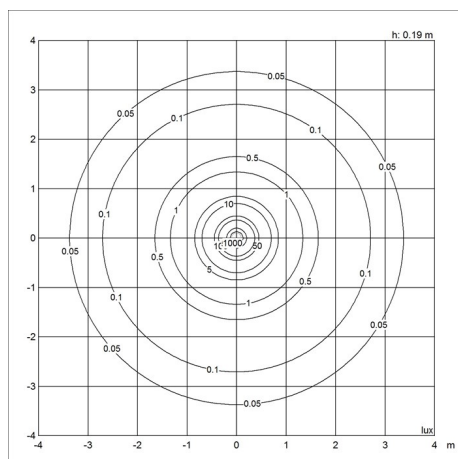

Polar

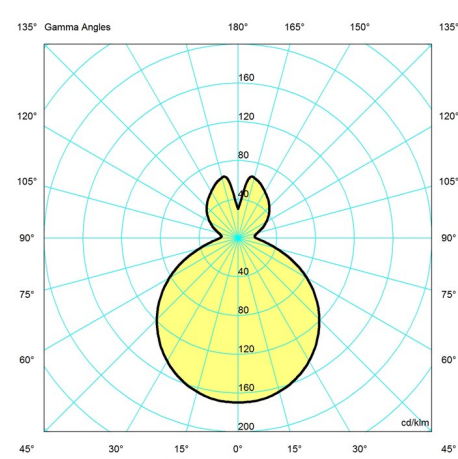

Data specifications

Colour	Opal	Length	220
Width	220	Height	284
Built-in Height	-	IP class	20
Class	II	Net Weight	0.9
Standby (W)	-	Power Factor (P = 100 % / P = 50 %)	-
Inrush Current	-	Light source	1x20W E14
Kelvin	-	CRI	-
SDCM	-	Lumen	-
Watt	-	Efficacy	-
Light control	-	Min. Dim Level (%)	-
UGR Transversal / Axial	15.9/15.9	L80B50 (hours)	-
Driver life	-		

AJ Oxford Table Lamp

AJ Oxford Table Lamp - 5744168627

This table lamp emits a pleasant downward directed light, which harmoniously illuminates the surface below it through the soft transparency of the three-layered mouth-blown opal glass. The variant without the top metal shade, the milky opal glass shade provides further glow to form an alluring halo around the fixture.

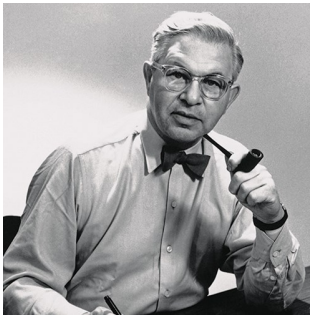

Arne Jacobsen

Arne Jacobsen was born and raised in Copenhagen. In 1927, he graduated as an architect from the Royal Danish Academy of Fine Arts in Copenhagen. After graduating, he obtained his first job at the office of the City Architect of Copenhagen launching his own office only two years later.



Product info

Information

Union nut and fingerscrew in untreated brass which will patinate. Pin solution for 410 mm with metal shade and 280 mm variants available upon request.

Mounting

Cable type: Black textile cord 2x0.75 mm² with plug. Cable length: 2.2m. Light control: On/off switch on socket house with union nut in untreated brass. Pin solution available for 410 mm: Cut-out dimension Ø44 mm, table thickness: 8 - 40 mm.

Finish

Black wet painted stem with shade in three layered mouth-blown opal glass. Top shade: Black wet painted with white inner side.

Materials

Shade: Mouth-blown three layered white opal glass. Stem and top shade: Steel. Mounting device for pin mounting: Aluminium. Union nut and finger screw in untreated brass with fine clockwise hairlines. Please note the untreated brass will patinate.

Sizes and weights

Width x Height x Length (mm) | 220 x 413 x 220 Max 1.2 kg | 220 x 284 x 220 Max 1.1 kg | 220 x 410 x 220 Max 0.9 kg

Class

Ingress protection IP20. Electric shock protection II.

Light source

1x20W E14

Information

Union nut and fingerscrew in untreated brass which will patinate.

Pin solution for 410 mm with metal shade and 280 mm variants available upon request.

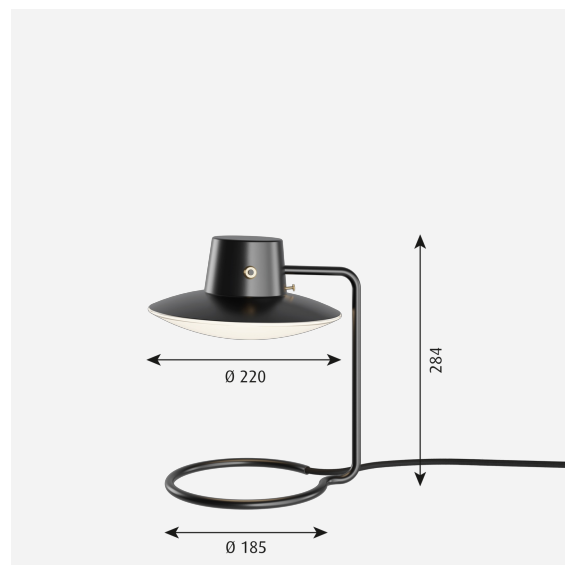

Product family

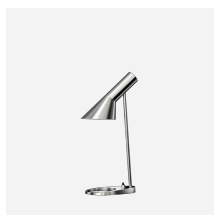

AJ Mini Table



AJ Royal



AJ Garden Bollard



AJ Table



AJ Wall

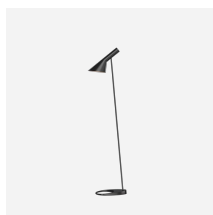

AJ Floor



AJ 50 Wall

Light distribution diagrams

Cartesian

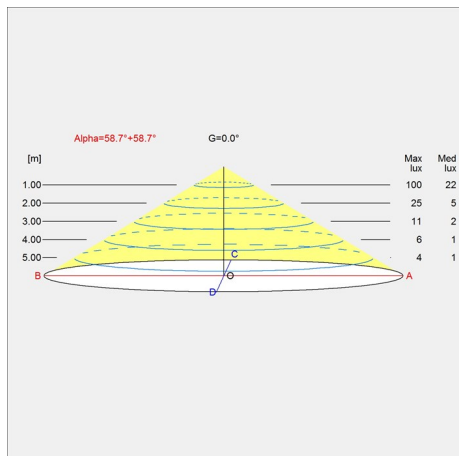

Isolux

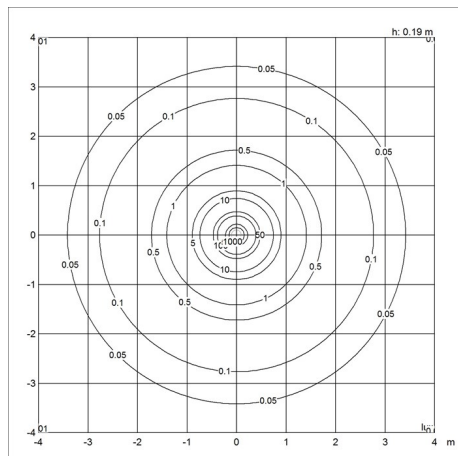

Polar

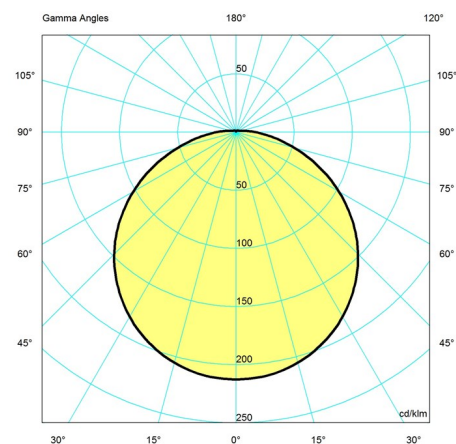

Data specifications

Colour	Metal black/opal glass	Length	220
Width	220	Height	284
Built-in Height	-	IP class	20
Class	II	Net Weight	1.1
Standby (W)	-	Power Factor (P = 100 % / P = 50 %)	-
Inrush Current	-	Light source	1x20W E14
Kelvin	-	CRI	-
SDCM	-	Lumen	-
Watt	-	Efficacy	-
Light control	-	Min. Dim Level (%)	-
UGR Transversal / Axial	19.4/19.4	L80B50 (hours)	-
Driver life	-		